

WINMAN SOLENOID VALVES

WVP0.S08.2 Valve Series



SAE Cartridge - 250 bar
Directional Valve - 3/2 Spool type

Description

A Solenoid operated, 3 way 2 positions, spool type, direct acting, screw-in hydraulic directional cartridge valve. In the de-energized mode, the SVP0.S08 allows flow bidirectionally between ports 1 and 2, while blocking flow at 3. In the energized mode, bidirectional flow is allowed between ports 2 and 3, while flow is blocked at 1. Even if port 1 may be fully pressurized, it is not intended to be used as the inlet.

The rigid design using a 1-piece body contributes to minimize the effect of eccentricities in cavity and provides great reliability.

Low pressure drop thanks to optimized flow path.

Technical Features

All external surfaces are zinc plated and corrosion-proof.

All valve parts are made of high strength steel.

Spool is hardened and micron finished to ensure minimal wear and extended service life.

Coil seals protect the solenoid system.

Manual override option.

Industry SAE common cavity.

Performance Details

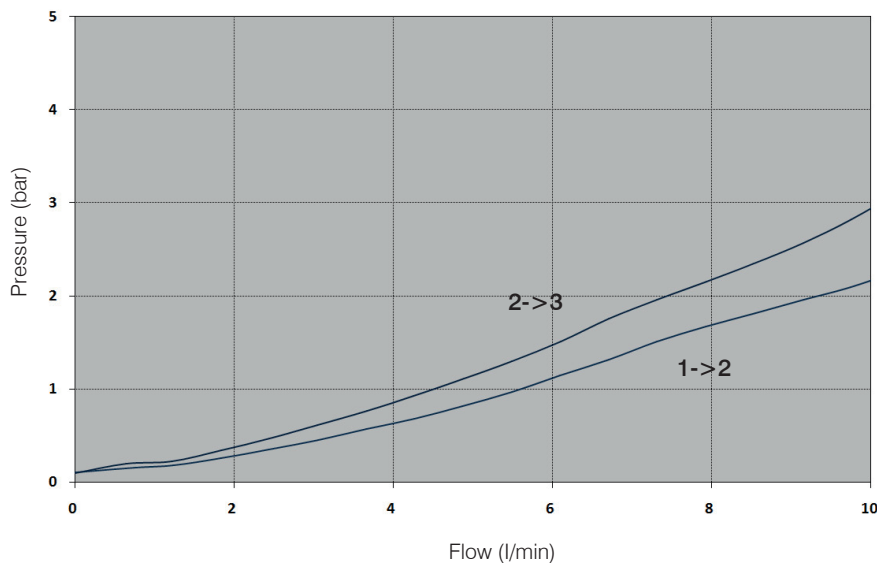

Symbols

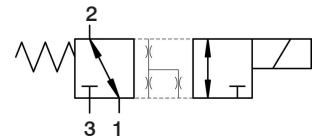

Technical Data

Maximum operating pressure: 250 bar

Maximum flow: 10 l/min

Internal leakage: max 85 cm³/min @ 250 bar

Temperature: -30°C to 110°C

Fluids: Mineral-based or synthetics with lubricating properties at viscosities of 7.4 to 420 cSt

Minimum pull-in voltage: 85% of nominal

Orientation: no restrictions

Installation torque: 35-40 Nm

Seal kit code: SK.035 and SK.027 (coil)

Weight: 0.140 kg

NOTE: The performance chart illustrates flow handling capacity 1 to 2 (de-energized) and 2 to 3 (energized).

P/Q curves are recorded at TOil = 40°C and 46 cSt

WINMAN SOLENOID VALVES

Cross Section

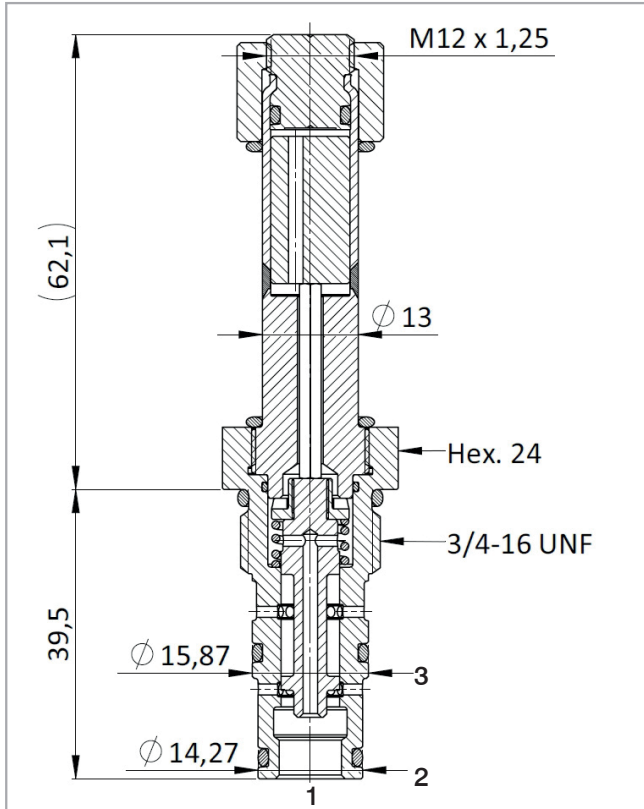

Cavity Details

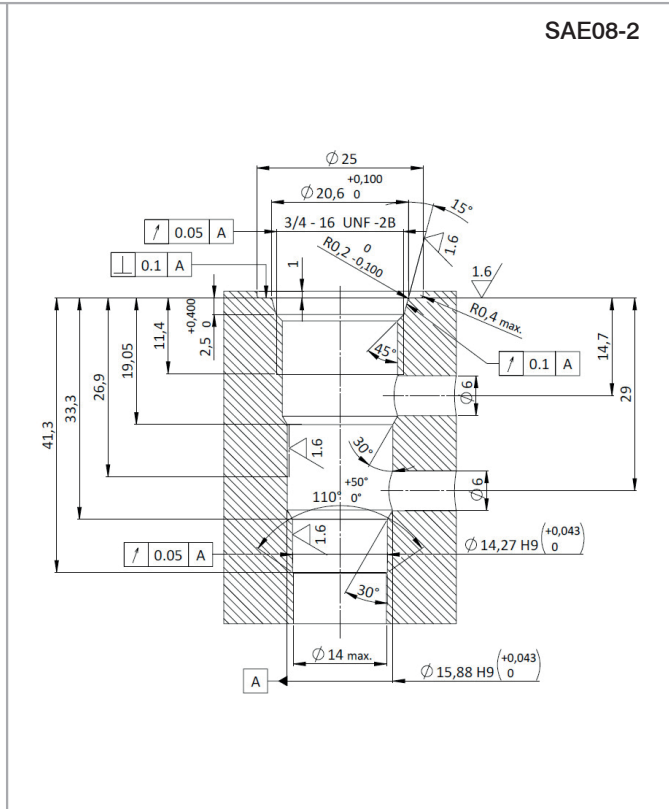

Ordering Code

W V P 0 • S 0 8 • 0 * • 2 0 0

Valve basic code

Cavity

S08 = 3/4-16 UNF with Ø15,87 and Ø14,27 nose sizes

Flow path

1 and 2 connected, 3 blocked (de-energized)
2 and 3 connected, 1 blocked (energized)

Manual override

Marking

0=Standard factory marking
Customized markings can be done upon request

Manual Override

Model Code	Type of override
0	No override
3	Push pin
4	Push knob
8	Screw

Coil



Use 18W coil to operate this valve.